

ISSUING LOCAL AUTHORITY

Wiltshire Council



PART 1 – PREMISES & LICENCE HOLDER DETAILS

POSTAL ADDRESS OF PREMISES, OR IF NONE, ORDNANCE SURVEY MAP REFERENCE OR DESCRIPTION

Bath Arms, Crockerton, Warminster, Wiltshire, BA12 8AJ

NAME, (REGISTERED) ADDRESS AND CONTACT DETAILS OF HOLDER OF PREMISES LICENCE

The Chaffinch Pub Company Ltd
K5 The Courtyard , Jenson Avenue Commerce Park, Frome, BA11 2FG
Email: alison@absolutesolvents.co.uk

REGISTERED NUMBER OF HOLDER, FOR EXAMPLE COMPANY NUMBER, CHARITY NUMBER

12774379

NAME AND ADDRESS OF DESIGNATED PREMISES SUPERVISOR WHERE THE PREMISES LICENCE AUTHORISES THE SUPPLY OF ALCOHOL

Alison Gardner
[REDACTED]

ISSUING AUTHORITY AND PERSONAL LICENCE NUMBER HELD BY DESIGNATED PREMISES SUPERVISOR WHERE THE PREMISES LICENCE AUTHORISES FOR THE SUPPLY OF ALCOHOL

Wiltshire Council LN/19100

WHERE THE LICENCE IS TIME LIMITED - THE DATES AND TIMES

Not Applicable

WHERE THE LICENCE AUTHORISES SUPPLIES OF ALCOHOL WHETHER THESE ARE ON AND / OR OFF SUPPLIES

On and Off Sales

STATE WHETHER ACCESS TO THE PREMISES BY CHILDREN IS RESTRICTED OR PROHIBITED

Where applicable the provisions of Section 145 of the Licensing Act 2003 apply

PART 2 – LICENSABLE ACTIVITIES & TIMINGS

LICENSABLE ACTIVITIES AUTHORISED BY THE LICENCE						
Licensable activities	Location	Day	Time From	Time To	Time From	Time To
Alcohol Sales	ON and OFF Sales	Sunday	12:00	22:30		
		Monday	11:00	23:00		
		Tuesday	11:00	23:00		
		Wednesday	11:00	23:00		
		Thursday	11:00	23:00		
		Friday	11:00	23:00		
		Saturday	11:00	23:00		
Non-Standard Timings & Seasonal Variations	<p>Good Friday 12:00 hrs to 22:30 hrs Christmas Day 12:00 hrs to 15:00 hrs and 19:00 hrs to 22:30 hrs New Years Eve from the end of permitted hours until the start of permitted hours the following day Alcohol, hot food and hot drink may be sold or supplied for one hour following the hours set out above and on Christmas day, between 1500hrs and 1900hrs to persons taking table meals in the premises in a part of the premises usually set apart for the service of such persons and for consumption by such a person in that part of the premises as an ancillary to his meal. For other purposes or in other parts of the premises the hours set out above shall continue to apply.</p>					
Recorded Music	Indoors	Sunday	11:00	01:00		
		Monday	11:00	01:00		
		Tuesday	11:00	01:00		
		Wednesday	11:00	01:00		
		Thursday	11:00	01:00		
		Friday	11:00	01:00		
		Saturday	11:00	01:00		
Non-Standard Timings & Seasonal Variations						
Live Music	Indoors & Outdoors	Sunday	23:00	01:00		
		Monday	23:00	01:00		
		Tuesday	23:00	01:00		
		Wednesday	23:00	01:00		
		Thursday	23:00	01:00		
		Friday	23:00	01:00		
		Saturday	23:00	01:00		

Non-Standard Timings & Seasonal Variations						
Hrs premises open to public	Sunday	11:00	01:00			
	Monday	11:00	01:00			
	Tuesday	11:00	01:00			
	Wednesday	11:00	01:00			
	Thursday	11:00	01:00			
	Friday	11:00	01:00			
	Saturday	11:00	01:00			
Non-Standard Timings & Seasonal Variations						

Licence Commencement Date

24th November 2005



Licensing Officer

Last Amendment Date

22 July 2022

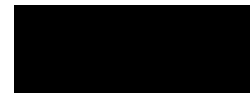

Licensing Officer

ANNEX 1 - MANDATORY CONDITIONS

Supply of Alcohol

1. Where this Licence authorises the supply of alcohol:

No supply of alcohol may be made under this licence:

- (a) At a time when there is no Designated Premises Supervisor in respect of the Premises Licence.
- (b) At a time when the Designated Premises Supervisor does not hold a Personal Licence or his Personal Licence is suspended.

Every retail sale or supply of alcohol made under this licence must be made or authorised by a person who holds a Personal Licence.

Exhibition of Films

1. Where a premises licence authorises the exhibition of films, the licence must include a condition requiring the admission of children to the exhibition of any film to be restricted in accordance with this section.
2. Where the film classification body is specified in the licence, unless subsection (3)(b) applies, admission of children must be restricted in accordance with any recommendation by that body.
3. Where:-
- (a) The film classification body is not specified in the licence, or
 - (b) The relevant licensing authority has notified the holder of the licence that this subsection applies to the film in question; admission of children must be restricted in accordance with any recommendation made by that licensing authority.
4. In this section “children” means any person aged under 18; and “film classification body” means the person or persons designated as the authority under Section 4 of the Video Recordings Act 1984(c39) (authority to determine suitability of video works for classification).

Irresponsible Promotions

1. The responsible person must ensure that staff on relevant premises do not carry out, arrange or participate in any irresponsible promotions in relation to the premises.
2. In this paragraph, an irresponsible promotion means any one or more of the following activities, or substantially similar activities, carried on for the purpose of encouraging the sale or supply of alcohol for consumption on the premises—
- (a) games or other activities which require or encourage, or are designed to require or encourage, individuals to—
 - i. drink a quantity of alcohol within a time limit (other than to drink alcohol sold or supplied on the premises before the cessation of the period in which the responsible person is authorised to sell or supply alcohol), or,
 - ii. drink as much alcohol as possible (whether within a time limit or otherwise);.
 - (b) provision of unlimited or unspecified quantities of alcohol free or for a fixed or discounted fee to the public or to a group defined by a particular characteristic in a manner which carries a significant risk of undermining a licensing objective;

- (c) provision of free or discounted alcohol or any other thing as a prize to encourage or reward the purchase and consumption of alcohol over a period of 24 hours or less in a manner which carries a significant risk of undermining a licensing objective;
- (d) selling or supplying alcohol in association with promotional posters or flyers on, or in the vicinity of, the premises which can reasonably be considered to condone, encourage or glamorise anti-social behaviour or to refer to the effects of drunkenness in any favourable manner;
- (e) dispensing alcohol directly by one person into the mouth of another (other than where that other person is unable to drink without assistance by reason of disability)

Free Tap Water

1. The responsible person must ensure that free potable tap water is provided on request to customers where it is reasonably available. (This means that responsible persons at all premises must ensure customers are provided with potable (drinking) water for free if they ask for it.)

Age Verification Policy

- (a) The premises licence holder or club premises certificate holder must ensure that an age verification policy is adopted in respect of the premises in relation to the sale or supply of alcohol.
- (b) The designated premises supervisor in relation to the premises licence must ensure that the supply of alcohol at the premises is carried on in accordance with the age verification policy.
- (c) The policy must require individuals who appear to the responsible person to be under 18 years of age (or such older age as may be specified in the policy) to produce on request, before being served alcohol, identification bearing their photograph, date of birth and either—
 - i. a holographic mark, or.
 - ii. an ultraviolet feature.

Drink Volume Measures

1. The responsible person shall ensure that:
 - (a) where any of the following alcoholic drinks is sold or supplied for consumption on the premises (other than alcoholic drinks sold or supplied having been made up in advance ready for sale or supply in a securely closed container) it is available to customers in the following measures:
 - i. beer or cider: ½ pint;
 - ii. gin, rum, vodka or whisky: 25 ml or 35 ml; and
 - iii. still wine in a glass: 125 ml.
 - (b) these measures are displayed in a menu, price list or other printed material which is available to customers on the premises; and
 - (c) where a customer does not in relation to a sale of alcohol specify the quantity of alcohol to be sold, the customer is made aware that these measures are available.

Permitted Price

1.
 - (a) A relevant person shall ensure that no alcohol is sold or supplied for consumption on or off the premises for a price which is less than the permitted price.
 - (b) For the purposes of the condition set out in paragraph 1—
 - A. “duty” is to be construed in accordance with the Alcoholic Liquor Duties Act 1979;
 - B. “permitted price” is the price found by applying the formula—

$$P = D + (D \times V)$$
 where—
 - i. P is the permitted price,

- ii. D is the amount of duty chargeable in relation to the alcohol as if the duty were charged on the date of the sale or supply of the alcohol, and
- iii. V is the rate of value added tax chargeable in relation to the alcohol as if the value added tax were charged on the date of the sale or supply of the alcohol;

C. "relevant person" means, in relation to premises in respect of which there is in force a premises licence—

- i. the holder of the premises licence,
- ii. the designated premises supervisor (if any) in respect of such a licence, or
- iii. the personal licence holder who makes or authorises a supply of alcohol under such a licence;

D. "relevant person" means, in relation to premises in respect of which there is in force a club premises certificate, any member or officer of the club present on the premises in a capacity which enables the member or officer to prevent the supply in question; and

E. "value added tax" means value added tax charged in accordance with the Value Added Tax Act 1994.

2. Where the permitted price given by Paragraph B of paragraph 2 would (apart from this paragraph) not be a whole number of pennies, the price given by that sub-paragraph shall be taken to be the price actually given by that sub-paragraph rounded up to the nearest penny.

3.

(1) Sub-paragraph (2) applies where the permitted price given by Paragraph B of paragraph 2 on a day ("the first day") would be different from the permitted price on the next day ("the second day") as a result of a change to the rate of duty or value added tax.

(2) The permitted price which would apply on the first day applies to sales or supplies of alcohol which take place before the expiry of the period of 14 days beginning on the second day.

Door Supervision (except theatres, cinemas, bingo halls and casinos)

1. Where a premises licence includes a condition that at specified times one or more individuals must be at the premises to carry out a security activity, each such individual must:
 - (a) be authorised to carry out that activity by a licence granted under the Private Security Industry Act 2001; or
 - (b) be entitled to carry out that activity by virtue of section 4 of the Act.
2. But nothing in subsection (1) requires such a condition to be imposed:
 - (a) in respect of premises within paragraph 8(3)(a) of Schedule 2 to the Private Security Industry Act 2001 (c12) (premises with premises licences authorising plays or films); or
 - (b) in respect of premises in relation to:
 - i. any occasion mentioned in paragraph 8(3)(b) or (c) of that Schedule (premises being used exclusively by club with club premises certificate, under a temporary event notice authorising plays or films or under a gaming licence), or
 - ii. any occasion within paragraph 8(3)(d) of that Schedule (occasions prescribed by regulations under that Act).
3. For the purposes of this section:
 - (a) "security activity" means an activity to which paragraph 2(1)(a) of that Schedule applies, and, which is licensable conduct for the purposes of that Act, (see Section 3(2) of that Act) and
 - (b) paragraph 8(5) of that Schedule (interpretation of references to an occasion) applies as it applies in relation to paragraph 8 of that Schedule.

ANNEX 2A – CONVERTED CONDITIONS

N/A

ANNEX 2B – OPERATING SCHEDULE

PREVENTION OF PUBLIC NUISANCE

- None

PUBLIC SAFETY

- None

PROTECTION OF CHILDREN FROM HARM

- None

PREVENTION OF CRIME AND DISORDER

- None

ANNEX 3 – CONDITIONS ATTACHED AFTER HEARING

None

ANNEX 4 – PLANS

Attached Separately

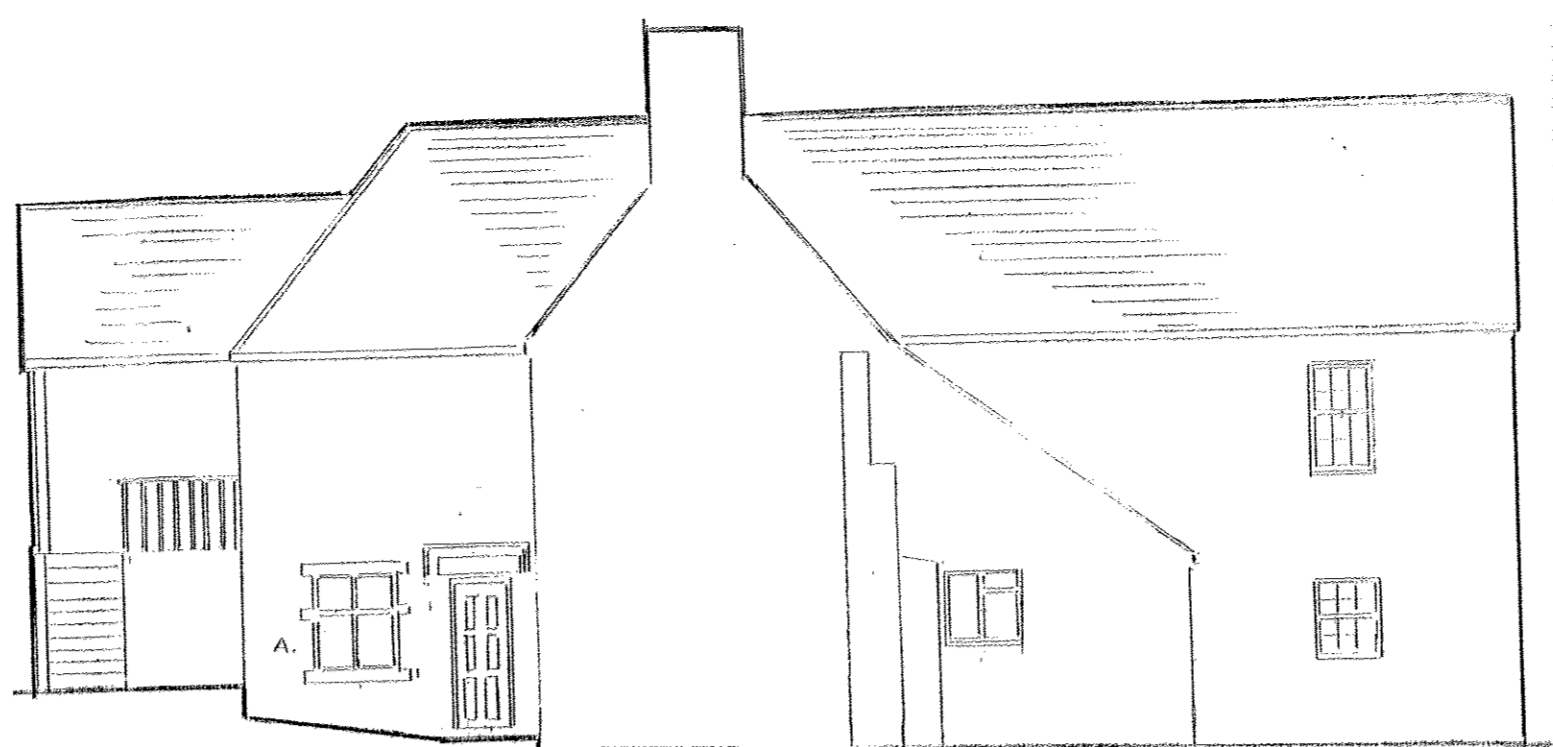
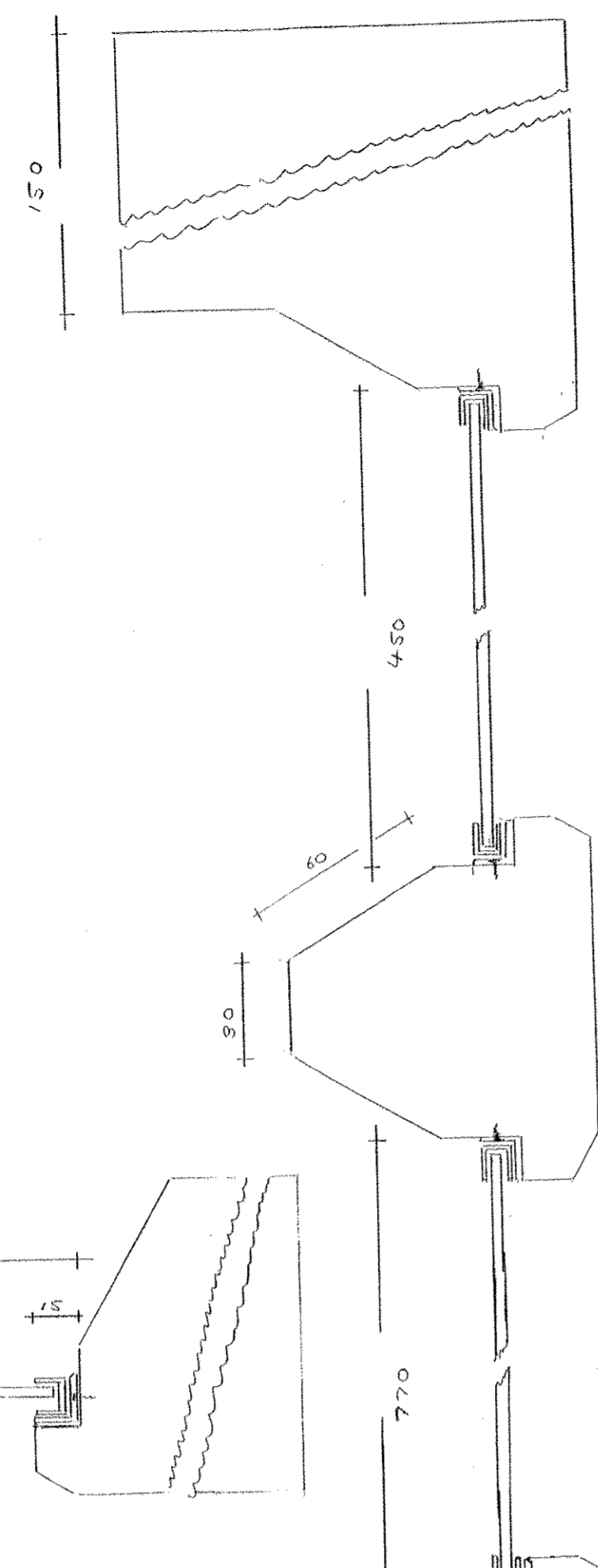
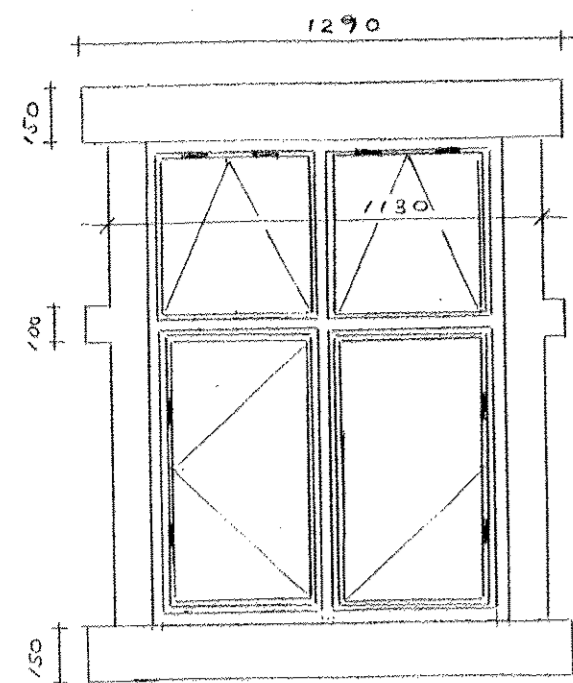

Existing East



Proposed East

NOTE: NO OTHER ELEVATIONS TO BE ALTERED

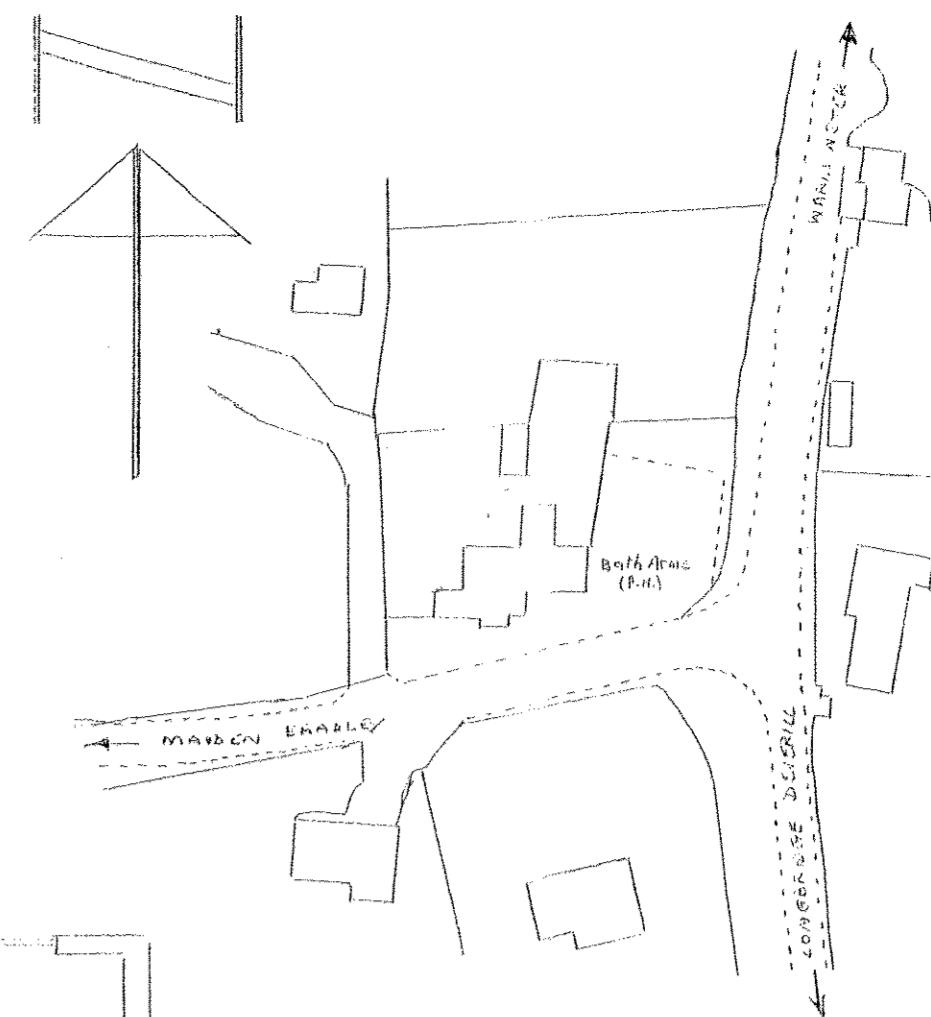

Site Location 1:1250



Proposed First Floor

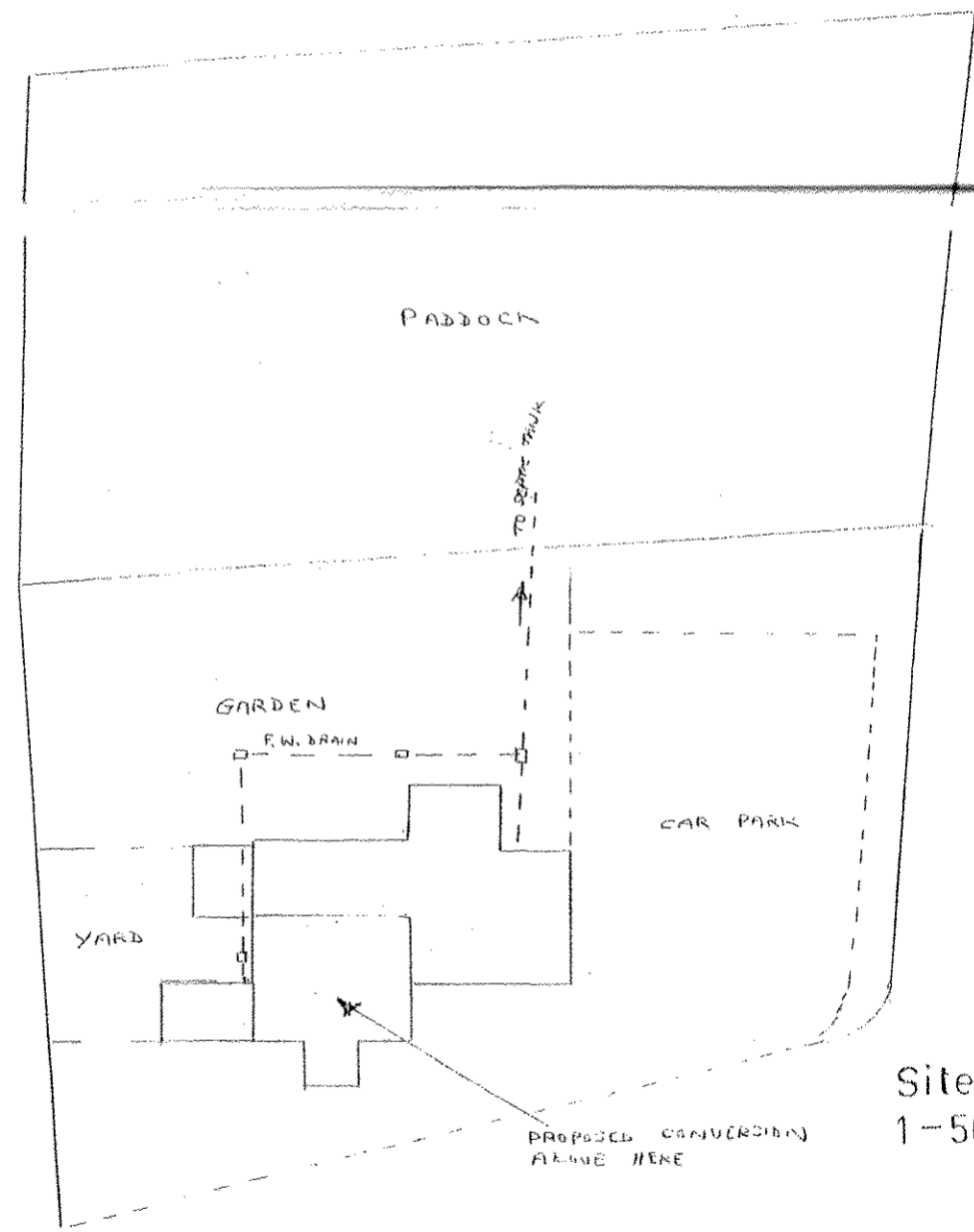

Site Layout 1:500

NATURAL STONE MULLIONS AND SASHES WITH BLACK PAINTED WOOD FRAMED SINGLE GLAZED WINDOWS ALL AS PER WINDOW 'A'

INTERNAL PARTITIONS OF TIMBER STUD OAK CLAD ON BOTH SIDES WITH SKIM COATED PLASTERBOARD.

EXTERNAL STAIRWAY DEMANTLED AND RE-BUILT TO SUITE AMBIENT DISABLED ACCESS, USING MATERIALS ON SITE.

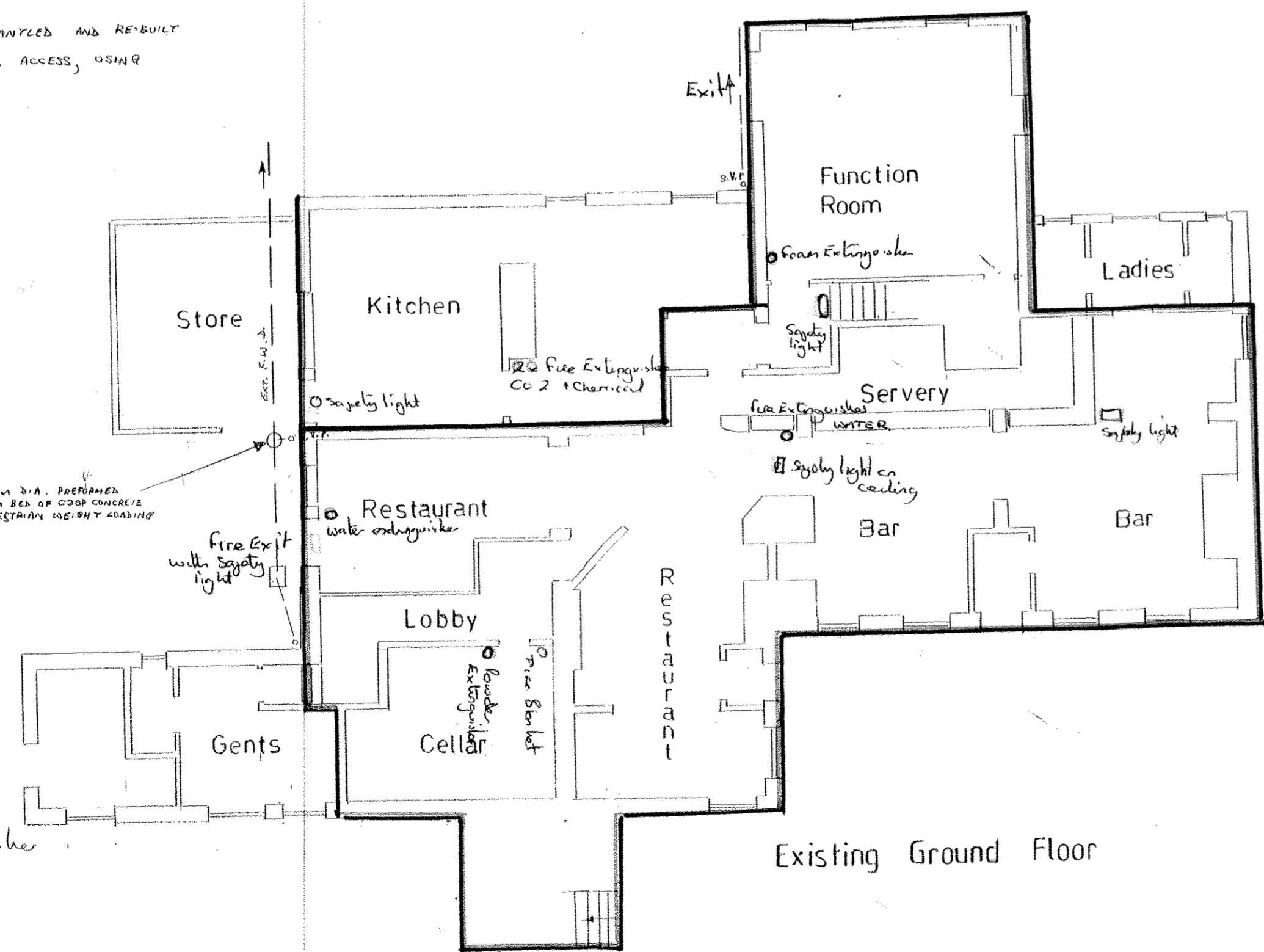

Existing Ground Floor

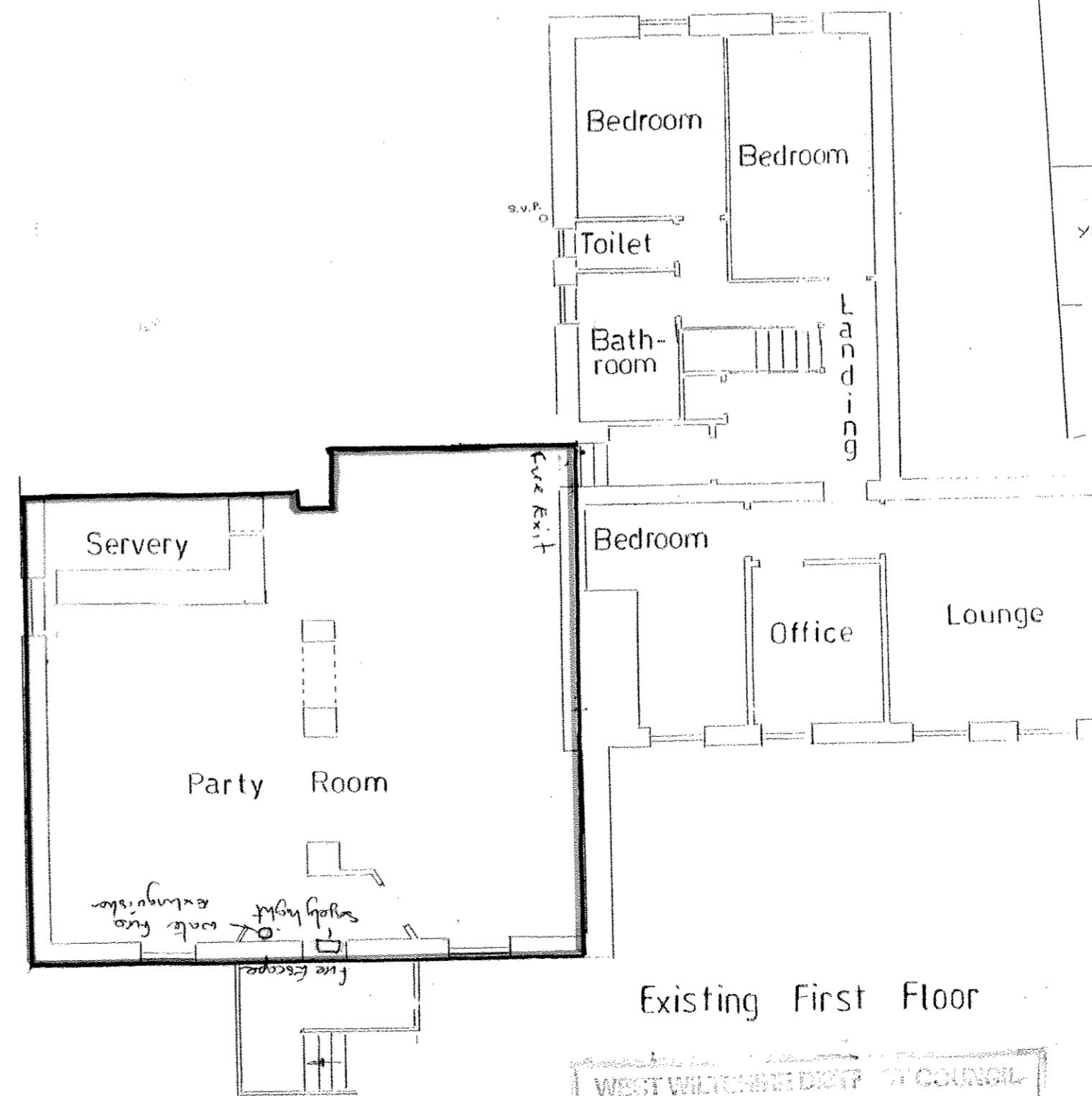

Existing First Floor

NEW FINISH: 100MM DIA. BEHEMOTH P.F.C. SPLIT END TUBING SET IN 100MM CONCRETE AND TOPPED WITH ALUMINIUM WEIGHT ADJUSTING COVER AND FRAME

Fire Extinguisher
Fire Exit
Safety light
Fire blanket

WEST WILTSHIRE DISTRICT COUNCIL
Licensing Dept
This plan submitted for Bath Arms
Licence No. W000501004-1-PRF
Date 24.11.95
Plan of 95

H GRIST 32 Daniell Crest Warminster Wilts. BA12 8NZ 01985 214346 Fax: 01985 214346			
Client	MR. D. CARR Bath Arms Crocker ton Warminster		
Project	Proposed Alterations		
Title	Plans & Elevations		
Drawn	HG	Date	Mar 05
Scale	1-100		
Drawing No	05017-1	Rev.	